

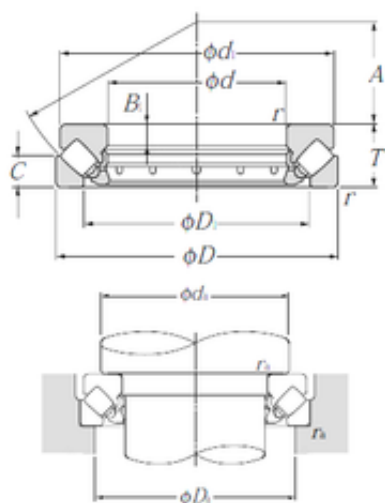

Original Koyo Bearing LTD



29322 NTN Thrust Spherical Roller Bearing

Bearing No. 29322

Size	110x190x48 mm
Bore Diameter	110 mm
Outer Diameter	190 mm
Width	48 mm
d	110 mm
D	190 mm
T	48 mm
B1	16 mm
C	23 mm
d1	182 mm
r min.	2 mm
A	64 mm
D1	143 mm
da min.	145 mm
Da max.	165 mm
ra max.	2 mm
Weight	5,78 Kg
Basic dynamic load rating (C)	445 kN
Basic static load rating (C0)	1 500 kN
Category	Roller Bearings
Inventory	0.0
Manufacturer Name	NTN
Minimum Buy Quantity	N/A
Weight / Kilogram	5.7
Product Group	B04311
bore diameter:	110 mm

29322 Bearing 2D drawings and 3D CAD models



Original Koyo Bearing LTD

maximum rpm:	1800 rpm
outside diameter:	190 mm
separable type:	Separable Bearing
overall width:	48 mm
fillet radius:	2 mm
operating temperature range:	-40 to 120 ° C
series:	293
static load capacity:	1500000 N
cage type:	Machined - Two Piece
bearing material:	Through Hardened Steel
enclosure:	Open
cage material:	Brass
manufacturer product page:	Click here
dynamic load capacity:	445000 N