

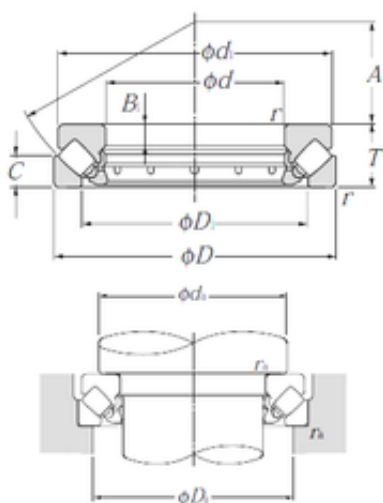

## Original Koyo Bearing LTD



### 29328 NTN Thrust Spherical Roller Bearing

Bearing No. 29328

Size	140x240x60 mm
Bore Diameter	140 mm
Outer Diameter	240 mm
Width	60 mm
d	140 mm
D	240 mm
T	60 mm
B1	20 mm
C	29 mm
d1	230 mm
r min.	2,1 mm
A	82 mm
D1	183 mm
da min.	185 mm
Da max.	205 mm
ra max.	2 mm
Weight	11,4 Kg
Basic dynamic load rating (C)	685 kN
Basic static load rating (C0)	2 360 kN
Category	Roller Bearings
Inventory	0.0
Manufacturer Name	NTN
Minimum Buy Quantity	N/A
Weight / Kilogram	11.22
Product Group	B04311
bore diameter:	140 mm

29328 Bearing 2D drawings and 3D CAD models



## Original Koyo Bearing LTD

maximum rpm:	1400 rpm
outside diameter:	240 mm
separable type:	Separable Bearing
overall width:	60 mm
fillet radius:	2.1 mm
operating temperature range:	-40 to 120 ° C
series:	293
static load capacity:	2360000 N
cage type:	Machined - Two Piece
bearing material:	Through Hardened Steel
enclosure:	Open
cage material:	Brass
manufacturer product page:	<a href="#">Click here</a>
dynamic load capacity:	685000 N